

# Hamilton Beach®

COMMERCIAL

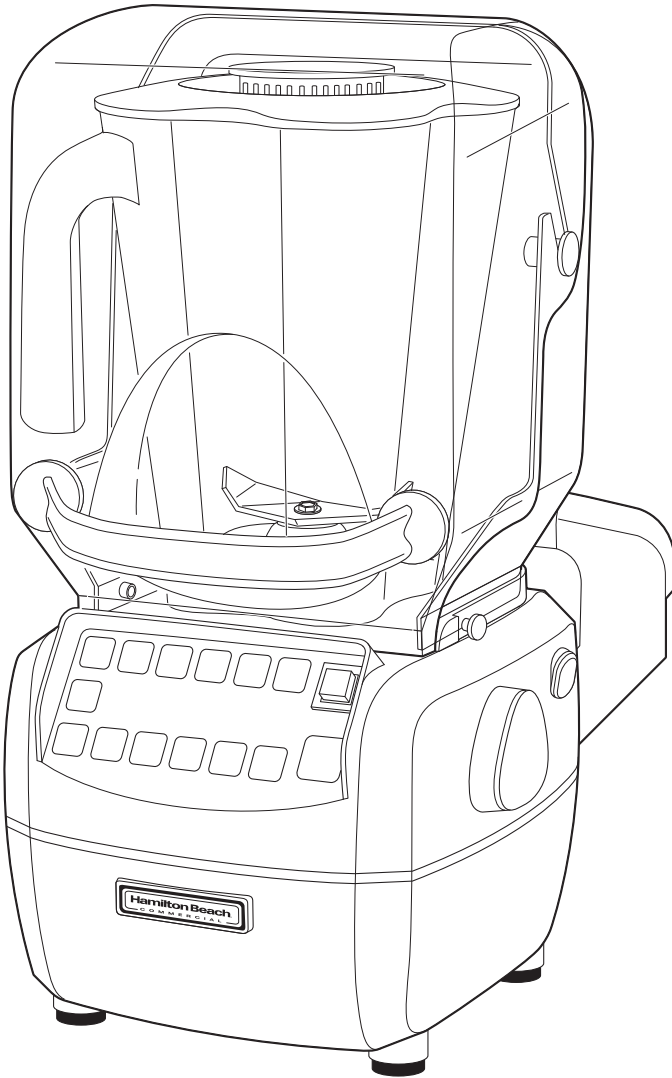

## SUMMIT®

### Hamilton Beach®

COMMERCIAL

- GB** **Summit Series Bar Blender**  
Operation Manual (2)
- FR** **Mélangeur de bar série Summit**  
Manuel d'utilisation (10)
- ES** **Mezcladora para bar Summit**  
Manual de operación (18)
- PT** **Liquidificador Série Summit**  
Manual do Utilizador (26)
- IT** **Frullatore per bar Summit**  
Manuale per il funzionamento (34)
- DE** **Standmixer der Summit Serie**  
Bedienungsanleitung (42)
- NL** **Summit Serie Barmixer**  
Gebruiksaanwijzing (50)
- DK** **Summit Series Bar-blender**  
Betjeningsvejledning (58)
- SE** **Summit-serien barblandare**  
Bruksanvisning (66)
- NO** **Serie Summit Hurtigmikser**  
Brukerhåndbok (74)
- GR** **Μπλέντερ για μπαρ Σειρά Summit**  
Εγχειρίδιο χειρισμού (82)
- RU** **Миксер для бара, серия Summit**  
Руководство по эксплуатации (90)
- TU** **Summit Series Bar blender**  
Çalıştırma Kılavuzu (98)
- BR** **Liquidificador Série Summit**  
Manual de Instruções (106)
- CN** **Summit 系列手提搅拌器**  
操作手册 (114)
- JP** **Summit バーブレンダー**  
操作マニュアル (122)
- KR** **Summit 시리즈 바 블렌더**  
사용 설명서 (130)
- SA** **Summit الخلاطة التجارية طراز**  
دليل التشغيل (138)

# Blender Safety

**IMPORTANT:** This operation manual should be reviewed with all equipment operators as part of your operator training program.

## IMPORTANT SAFETY INSTRUCTIONS

**WARNING** — When using electrical appliances, basic safety precautions should be followed, including the following:

- Read the Operation Manual before using blender. Keep Operation Manual handy.
- Before first use, wash container assembly in hot, soapy water. Do NOT place in dishwasher.
- Plug into a grounded outlet.
- Do not remove ground.
- Do not use an adapter.
- Do not use an extension cord.
- Disconnect power before cleaning or servicing.
- To reduce risk of personal injury, unplug cord from outlet when not in use, and before putting on or taking off parts.
- Unplug the blender and inspect the power cord insulation for cracks on a weekly basis. Refer to “Technical Services” for repair or replacement.
- To protect against electrical shock, do not immerse cord, plug, or blender base in water or any other liquid.
- Do not spray the base with a high-pressure spray gun.
- Extreme caution must be used when moving an appliance containing hot oil or other hot liquids.
- Do not use appliance for other than intended use.
- Not intended for use by or near children.
- Children should be supervised to ensure they do not play with the appliance.
- This appliance is not intended for use by persons (including children) with reduced physical, sensory, or mental capabilities, or lack of experience and knowledge, unless they have been given supervision or instruction concerning use of the appliance by a person responsible for their safety.
- The use of accessory attachments not recommended by the appliance manufacturer may cause injuries.
- To reduce risk of personal injury and to prevent damage to blender or container and cutter assembly, DO NOT insert utensils into blender container while operating blender.
- Do not store any kitchen utensils in the container because the blender would be damaged if inadvertently turned on.
- To prevent possibility of serious personal injury, keep hands out of blender container while operating blender. Always operate blender with container cover in place.
- Avoid contacting moving parts. Switch off the appliance and disconnect from power supply before changing accessories or approaching parts that move in use.
- Blades are sharp. Handle carefully when emptying container and during cleaning and inspecting of blades.
- If cutter assembly blades are loose, discontinue use immediately and replace cutter assembly. Do not attempt to repair or tighten cutter assembly.
- Inspect container and cutter assembly daily. Do not use broken, chipped, or cracked container. Check cutter for wear, nicks, or broken blades. Do not use broken, loose, or cracked cutting blades.
- Do not use outdoors.
- This appliance is intended for short periods of operation, with a rated operating time of 3 minutes.
- Do not leave blender unattended while it is operating.
- To prevent damage to blender, container, or cutter assembly, DO NOT move or shake blender while in operation. If blending action stops during operation, turn blender OFF (O), remove container from base, remove container cover, and use a thin rubber spatula to push mixture towards cutters.
- When blending hot liquids, remove center piece of two-piece lid. Hot liquids may push lid off jar during blending. To prevent possible burns: Do not fill blender jar beyond the 1 quart (1 liter) level. With the protection of an oven mitt or thick towel, place one hand on top of lid. Keep exposed skin away from lid. Start blending at lowest speed.
- Always operate blender with container cover in place.
- Do not defeat the jar pad sensors.
- Do not drop or slam the Quiet Shield™.
- Keep fingers away from edges and joints when opening and closing the Quiet Shield™.
- Always use the handle to open and close the Quiet Shield™.
- Do not strike the container against a surface to loosen ingredients.
- Do not carry the unit by the power cord.
- Do not immerse in liquids or wash the blender base in a dishwasher.
- Do not place blender base in or near liquids.
- Only authorized service facilities should repair the blender.
- Do not operate the above-the-counter model without the lower housing securely in place.
- This product is not intended to be installed in an unventilated cabinet. Ensure that there is a minimum of 7.75 in<sup>2</sup> (5000 mm<sup>2</sup>) of ventilation below the cabinet when operating in the in-counter configuration.
- This blender is designed with motor overload protection. If the motor stops during operation due to overheating, unplug the unit and allow it to cool down for 15 minutes. Plug unit back in after 15 minutes to resume normal operation.
- The normal function of this product may be disturbed by strong electromagnetic interference. If this occurs, simply reset the product and resume normal operation by following the operation manual. If normal operation cannot be resumed, place the product in a different location.
- The USB port on this product is not intended to be connected to a PC or any other electronic device. Use it only to upload programs provided by the manufacturer on a USB flash drive.
- Do not operate any appliance with a damaged cord or plug or after the appliance malfunctions, or is dropped or damaged in any manner. Refer to “Technical Services” for instructions on examination, repair, or electrical or mechanical adjustment.
- If the supply cord of this appliance is damaged, it must be replaced by the manufacturer or its service agent or a similar qualified person.

**UK ONLY:** If fitted with a non-rewirable U.K. plug, the 13-amp fuse approved by ASTA to be B.S. 1362 must be used. If you need a replacement fuse carrier, it must be replaced with the same colour-coded carrier with the same markings. Fuse covers and carriers can be obtained from approved service agents.

**- SAVE THESE INSTRUCTIONS -**

### Safety Alert Symbols

The following safety alert symbols are used throughout this manual to alert you to the safety hazards described below.

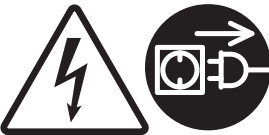

**Electrical Shock Hazard**  
 Disconnect power before cleaning blender base.  
 Failure to follow these instructions can result in death or electrical shock.



**Electrical Shock Hazard**  
 Plug into a grounded outlet.  
 Do not remove ground.  
 Do not use an adapter.  
 Do not use an extension cord.  
 Failure to follow these instructions can result in death, fire, or electrical shock.



**Cut Hazard**  
 Always place cover on container when blending.  
 Do not put hands, spoons, or other utensils in container when blending.  
 Failure to follow these instructions can result in broken bones, cuts, or other injuries.





**Burn Hazard**  
 Always use caution when blending hot contents.  
 Failure to follow these instructions can result in burns.

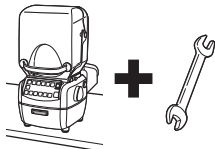

## Sanitizing

Sanitize using 1 tablespoon (15 ml) of household bleach per 1 gallon (3.8 liter) of clean, cool water (60°F/16°C), mixed according to the instructions on the bleach.



1. Fill container with sanitizing solution, replace cover and filler cap and run on LOW (1) speed for 2 minutes. Empty container.
2. Wipe exterior with soft cloth dampened with sanitizing solution.
3. Immerse cover and filler cap in sanitizing solution for 2 minutes.
4. Place empty container on base and run on HIGH (2) speed for 2 seconds to remove any moisture from the cutter assembly.
5. **When ready to use**, rinse with clean water.

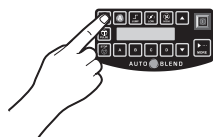

**146**

**148**

**150**

**152**

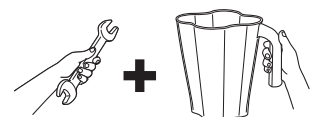
## Technical Services

For assistance or replacement parts, call our  
**Technical Services number:**  
**++866-285-1087**  
[www.commercial.hamiltonbeach.com](http://www.commercial.hamiltonbeach.com)

### INSTRUCTIONS FOR PROPER DISPOSAL OF THIS PRODUCT PURSUANT TO THE EUROPEAN UNION'S DIRECTIVE ON ELECTRICAL WASTE

Please do not dispose of any electrical equipment as ordinary waste. Help conserve natural resources and protect the environment: when you have finished using this product, please dispose of it at your local waste collection or recycling centre in the area reserved for electrical equipment. Contact your local authority to find the nearest waste collection centre. To remind you to dispose of this product responsibly and separately from ordinary waste, it is marked with the symbol of a crossed-out trash bin.



# Parts and Features

The parts and features for the Summit® blenders are shown on this page. Become familiar with all parts and features before using your blender. For questions, call Technical Services at 1-866-285-1087 or visit our Web site at: [www.commercial.hamiltonbeach.com](http://www.commercial.hamiltonbeach.com)

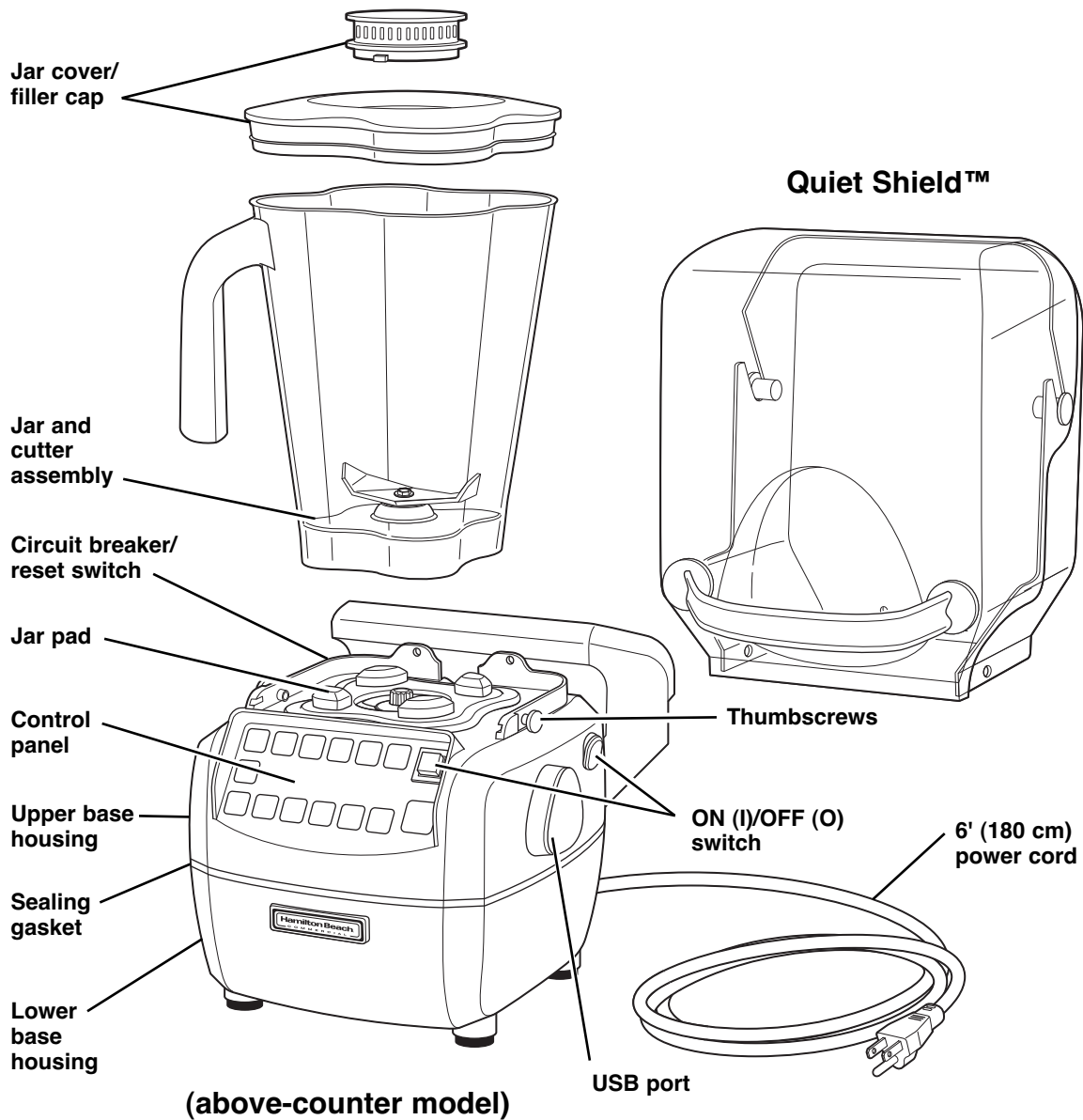

## To Load Custom Programs with the USB Port:

1. Turn off and unplug unit.
2. Remove USB port cover.
3. Insert USB card.
4. Plug in unit and turn on.
5. Display will show a confirmation message.
6. Turn off and unplug unit.
7. Remove USB card and reinstall USB port cover.

# Properly Installing the Quiet Shield™

**NOTICE:** Ensure the Quiet Shield™ is installed correctly. Breakage can occur if the dovetail joints along the bottom edges of the Quiet Shield™ are not properly interlocked with the upper base housing.

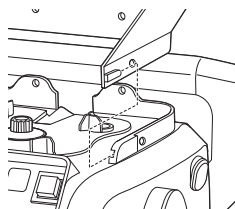

Align the dovetail joints along the base of the Quiet Shield™ with the cutout notches on the upper base housing.



Slide Quiet Shield™ into place. If necessary, hold the edges of the shield open to ensure a secure fit.

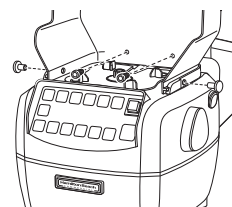

Install thumbscrews to secure Quiet Shield™ to upper base housing.

## Control Panel

**AUTOBLEND button**  
Blender automatically stops when drink is at right consistency.

**JUMP button**  
Blender automatically changes speed from LOW to HIGH during cycle.

**LOW/HIGH buttons**  
Use to select blending speed.

**START button**  
Starts selected cycle.

**PULSE button**  
Press and hold to run blender at HIGH for short bursts.

**STOP button**  
Stops operation of selected function. Does not shut off power to blender.

**Custom cycle buttons A-D**  
Store favorite cycles and recall them quickly using buttons A-D.

**UP/DOWN buttons**  
Press ▲ or ▼ button to scroll through options in display or to adjust settings.

**POWER ON (I)/ OFF (O) button**  
Turns blender on and off. May be located on the side of select models.

**Display**  
See following pages for status messages.

**MORE**  
Press to display additional text.

**NOTE:**  
The display will show last cycle run when not in use.

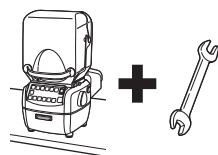

# Using the Controls

There are several blending options available, including **AUTOBLEND**, **JUMP** cycles, **HIGH**, or **LOW** cycles, each with adjustable time settings. You may also store favorite settings for later use with the **A**, **B**, **C**, or **D** buttons. For quick blending or to “freshen up” a beverage, use the **PULSE** button.

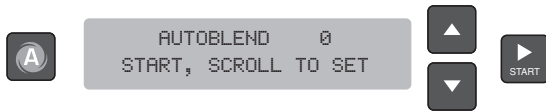

This is the default screen for the blender or if **AUTOBLEND** is pressed. On setting 0, the blender senses when the drink is finished and stops automatically. Press **▲** or **▼** button to change to **AUTOBLEND 1, 2, or 3** to add additional time. Press **START** to run cycle.

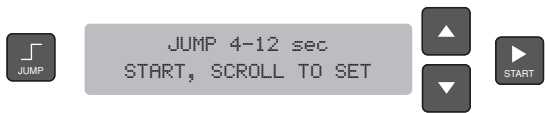

Pressing **JUMP** displays the default jump cycle times (4 seconds at low, then 12 seconds at high). Press **▲** or **▼** button to change the cycle length. Press **START** to run cycle.



Pressing **HIGH** or **LOW** displays current run time for that speed. Press **▲** or **▼** button to change cycle length. Press **START** to run cycle.

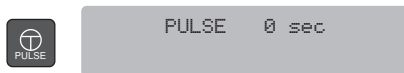

Press and hold the **PULSE** button to run blender at **HIGH** speed. Release to stop blender. Display will indicate length of time the button is held.

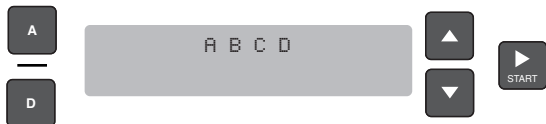

These buttons allow you to save your favorite settings. Select **A**, **B**, **C**, or **D** and press **START** to run cycle stored in that location. To store a new cycle, adjust the speed and time settings, then press and hold **A**, **B**, **C**, or **D** button for 3 seconds to save it to that location. A confirmation message will show when cycle is **SAVED**.

**NOTE:** Saving a new cycle to a location will overwrite any existing cycle in that location.



Pressing **STOP** will stop any cycle currently in use.



Pressing the **MORE** button displays cycle count screens and other diagnostic information.

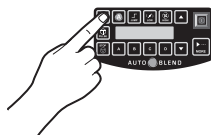

# Special Control Functions

Pressing the **MORE** button displays cycle count screens and other diagnostic information, and also allows you to access special functions.

Use ▲ or ▼ button to scroll through the options. Press **START** button to select that option.

---

## SPECIAL FUNCTIONS

CUSTOMER SERV. INFO  
START TO SELECT

Displays Hamilton Beach Commercial technical service number.

RUN COOLDOWN CYCLE  
START TO SELECT

If blender motor overheats, this message will be displayed to prompt you to run a cool-down cycle. Remove container from blender and press **START**. Once cycle has completed and motor has cooled to a proper operating temperature, display will revert to standby message.

AUTOBLEND 1 :B  
START TO SELECT

Allows you to select and edit the preset cycle for the indicated button.

A NOT SET  
START TO SELECT

Indicates that there are no stored cycle settings for the indicated button.

SET FACTORY DEFAULTS  
START TO SELECT

Resets all settings except cycle counts to factory presets.

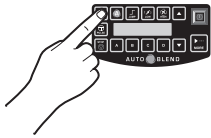

# Special Control Functions

Pressing the **MORE** button displays cycle count screens and other diagnostic information, and also allows you to access special functions.

Use ▲ or ▼ button to scroll through the options. Press **START** button to select that option.

---

## CYCLE COUNTS

CYCLES INTO WARRANTY  
START TO SELECT

Displays total number of cycles into warranty period.

CYCLES THIS WEEK  
START TO SELECT

The display allows you to show total number of cycles this year, this month, this week, or for the day. Use ▲ or ▼ button to scroll through the options. Press **START** button to select desired time period to be displayed.

CLEAR WEEKLY CYCLES  
START TO SELECT

You may clear (reset) number of cycles for any given time frame except number of cycles into warranty. Use ▲ or ▼ button to scroll through the options. Press **START** button to clear cycle counts for desired time period.

CLEAR ALL CYCLES  
START TO SELECT

You may also clear (reset) ALL stored cycle counts except number of cycles into warranty. Press **START** button to select. A confirmation message will be displayed to confirm that you wish to clear all cycle counts.

CLEAR ALL CYCLES  
PRS START TO CONFIRM

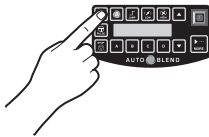



# Troubleshooting Guide

| Problem . . .                                                                 | Solution . . .                                                                                                                                                                                                                                                                                                                                                                                                                                                                                                                                                                                                                                                                                                                 |
|-------------------------------------------------------------------------------|--------------------------------------------------------------------------------------------------------------------------------------------------------------------------------------------------------------------------------------------------------------------------------------------------------------------------------------------------------------------------------------------------------------------------------------------------------------------------------------------------------------------------------------------------------------------------------------------------------------------------------------------------------------------------------------------------------------------------------|
| Blender fails to start or stops while running and display is blank.           | <ul style="list-style-type: none"> <li>• Make sure that main power ON (I)/OFF (O) button is ON (I).</li> <li>• Check to see if unit is securely plugged into an electrical outlet of proper voltage and frequency.</li> <li>• Check to see if fuse for electrical outlet has blown or if circuit breaker has tripped.</li> <li>• Check integrated circuit breaker on left side of blender base. If it trips again immediately or frequently, contact Technical Services.</li> <li>• Blender is equipped with motor overload protection. If motor stops during operation due to overheating, unplug and allow blender to cool down for 15 minutes. Plug blender back in after 15 minutes to resume normal operation.</li> </ul> |
| Blender fails to start or stops while running; message appears in display.    | <ul style="list-style-type: none"> <li>• Make sure that jar is seated properly on blender base.</li> <li>• Blender will not operate unless jar is properly seated.</li> </ul>                                                                                                                                                                                                                                                                                                                                                                                                                                                                                                                                                  |
| Blender fails to start or stops while running.                                | <ul style="list-style-type: none"> <li>• Thermal overload protection has been tripped. Attempt to run “cool-down cycle.” Follow instructions in display.</li> <li>• Blender is equipped with motor overload protection. If motor stops during operation due to overheating, unplug and allow blender to cool down for 15 minutes. Plug blender back in after 15 minutes to resume normal operation.</li> </ul>                                                                                                                                                                                                                                                                                                                 |
| Unit does not respond to button commands or error message appears in display. | <ul style="list-style-type: none"> <li>• Turn power off and back on using power switch to reset controls.</li> <li>• Turn power off and back on using power switch. If error message still appears, unit will need to be serviced.</li> </ul>                                                                                                                                                                                                                                                                                                                                                                                                                                                                                  |
| Ingredients will not mix properly.                                            | <ul style="list-style-type: none"> <li>• Check to see if enough liquid has been added to the ingredients. Mixture should be fluid and free-running at all times.</li> <li>• Solid pieces are too large.</li> <li>• Container is too full. Do not fill past highest graduation marking.</li> <li>• Cutter assembly blades are not sharp or are damaged. Inspect container and cutter assembly daily. Replace cutter assembly at least yearly or sooner if cutter assembly appears worn or damaged.</li> <li>• Check to see if cutter assembly is installed properly.</li> <li>• Select speed to create a fluid blend.</li> </ul>                                                                                                |

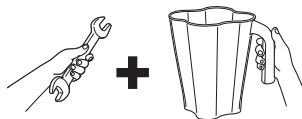

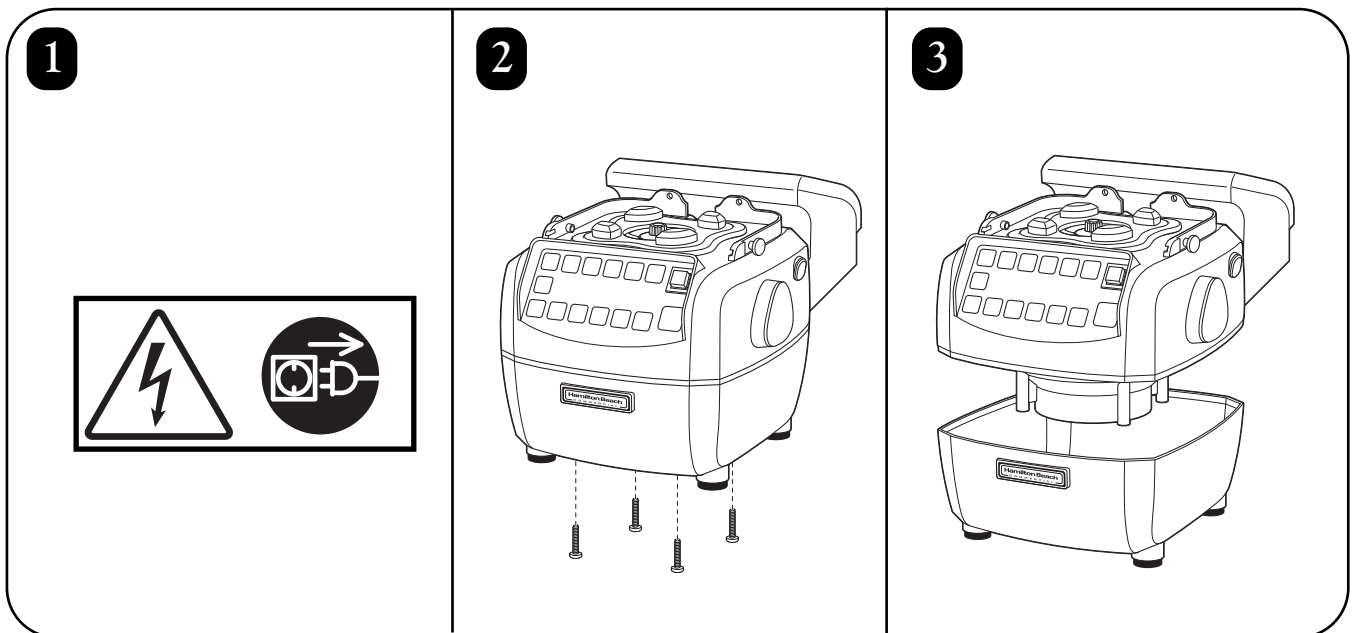
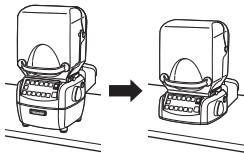
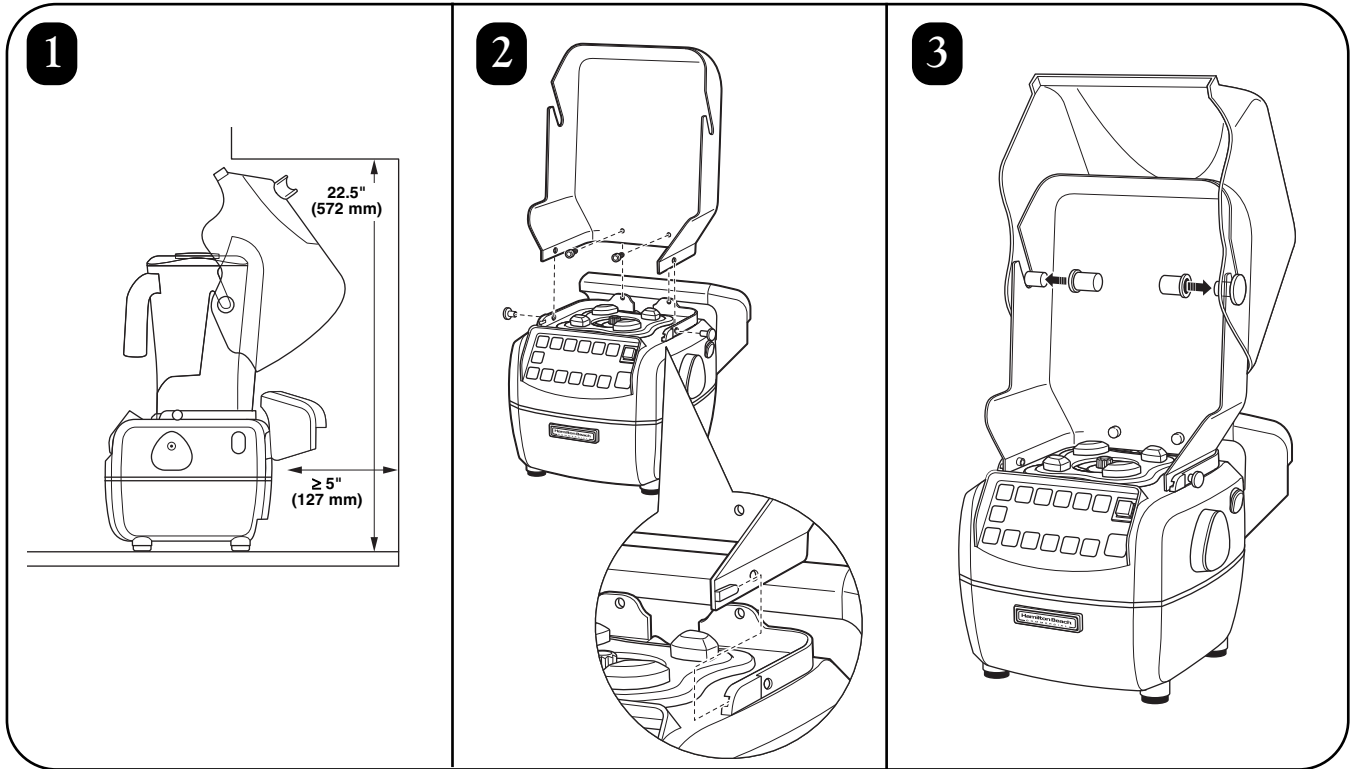
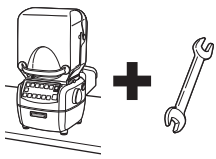

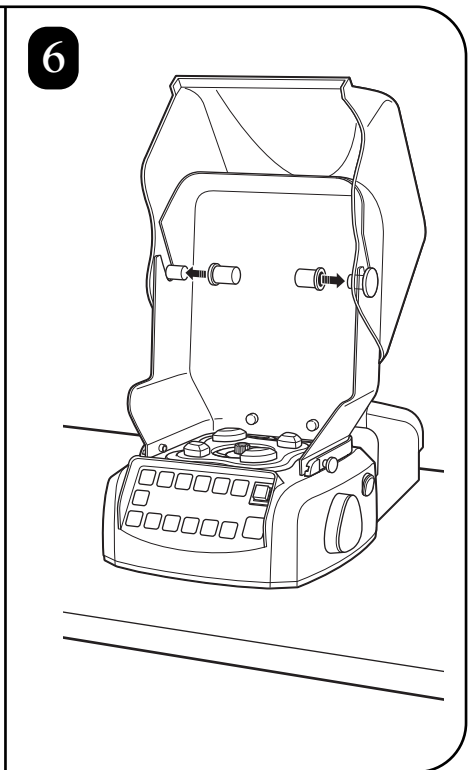
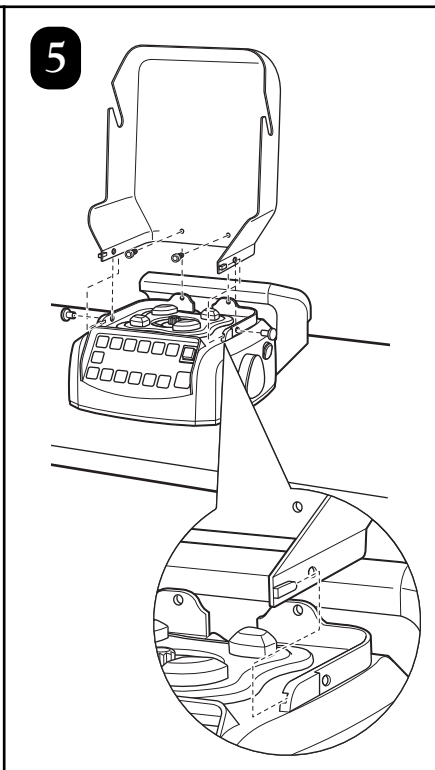
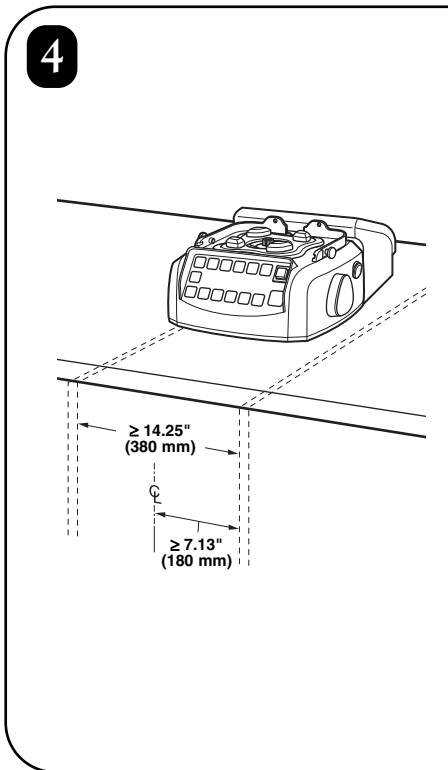
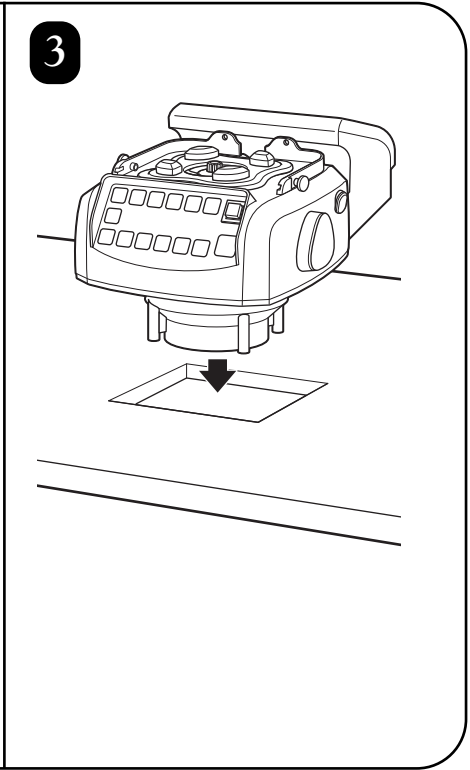
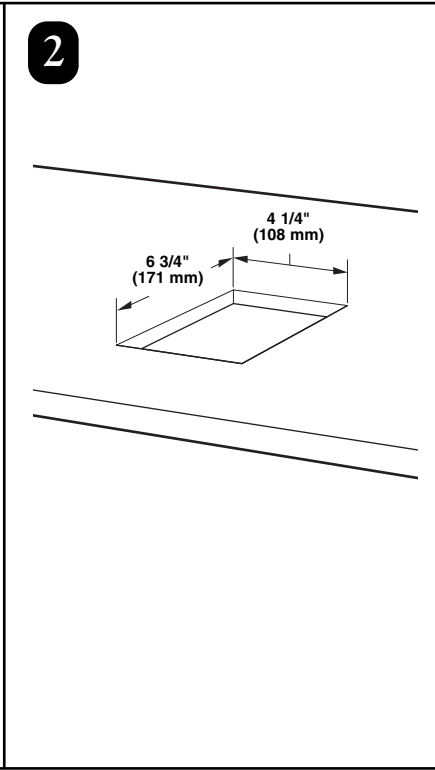
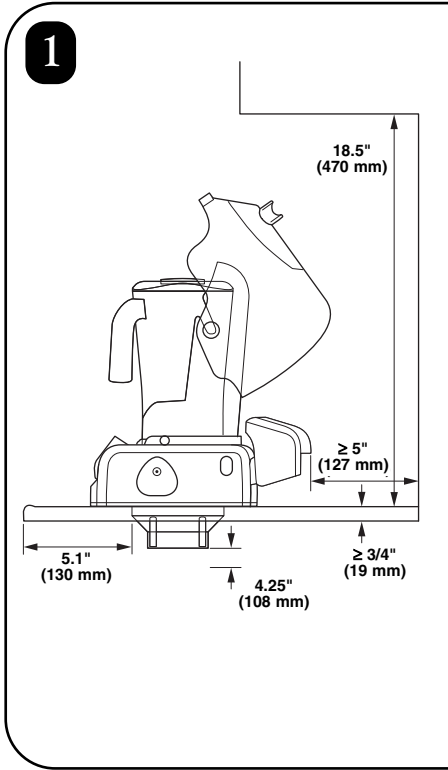
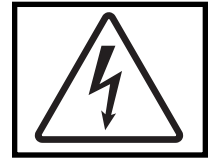
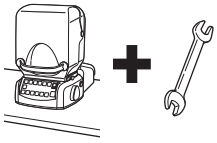

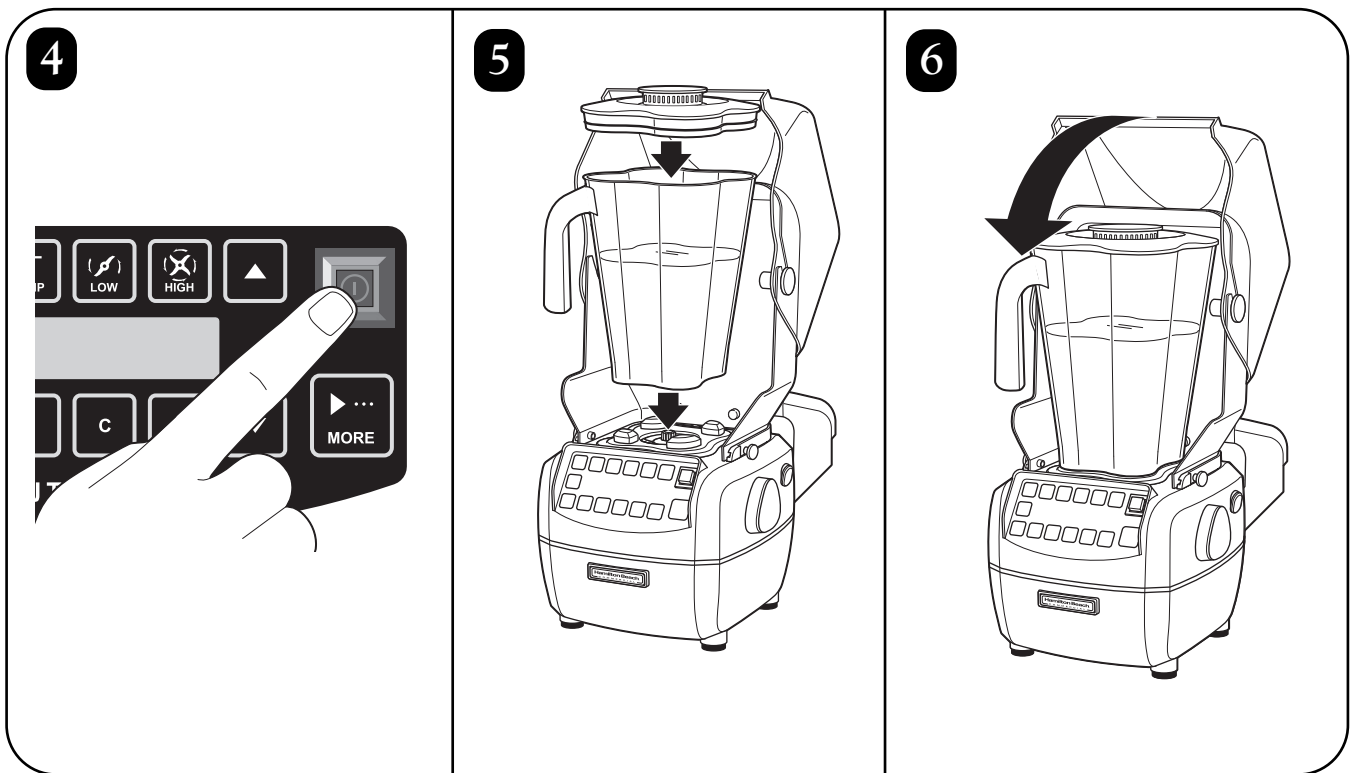
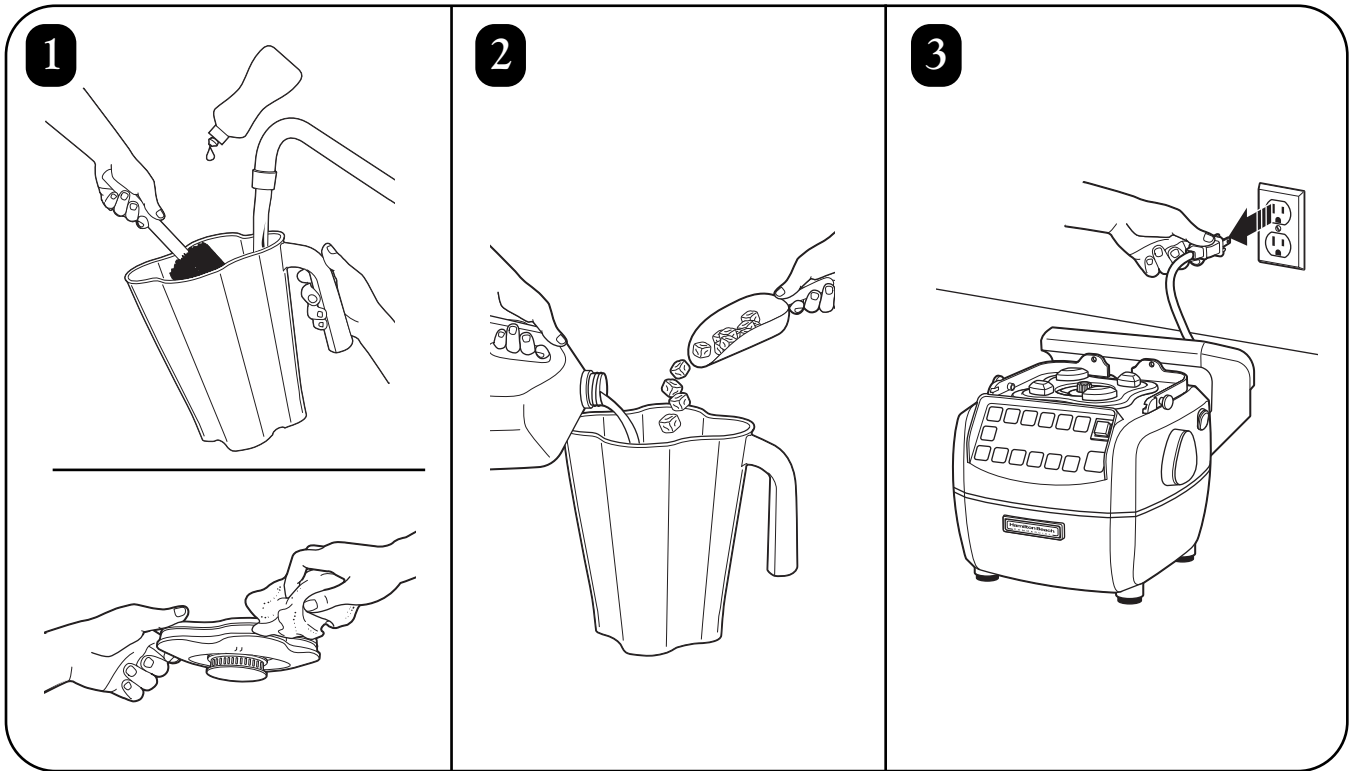
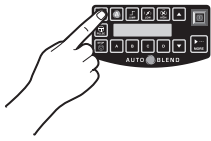

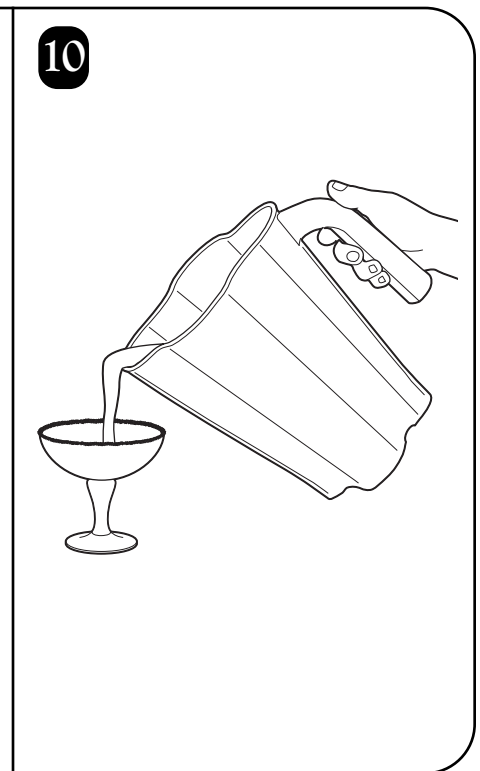
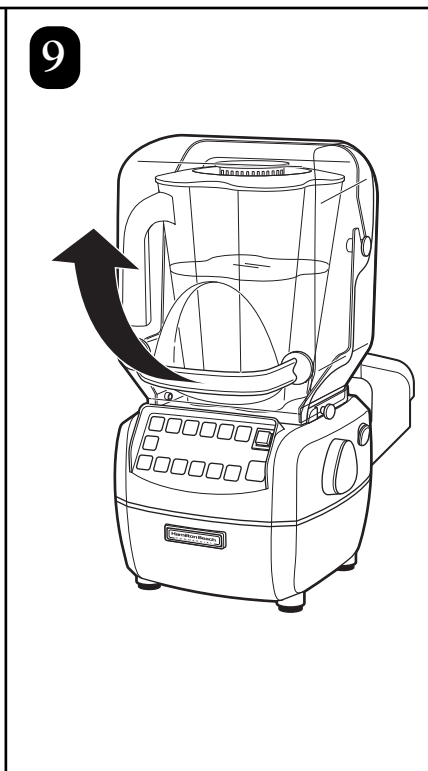
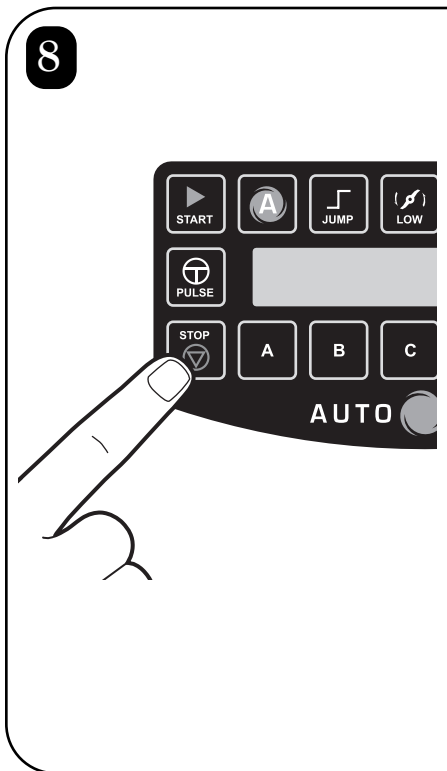
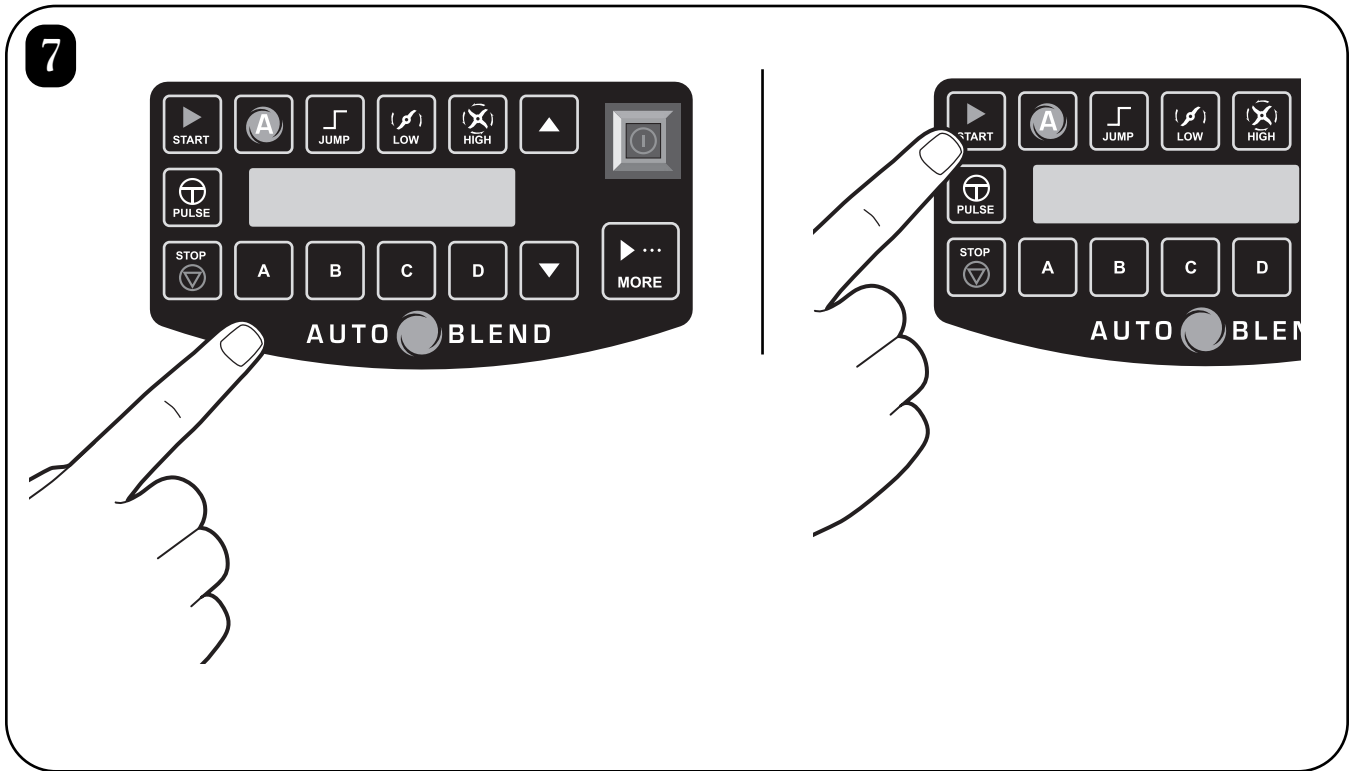

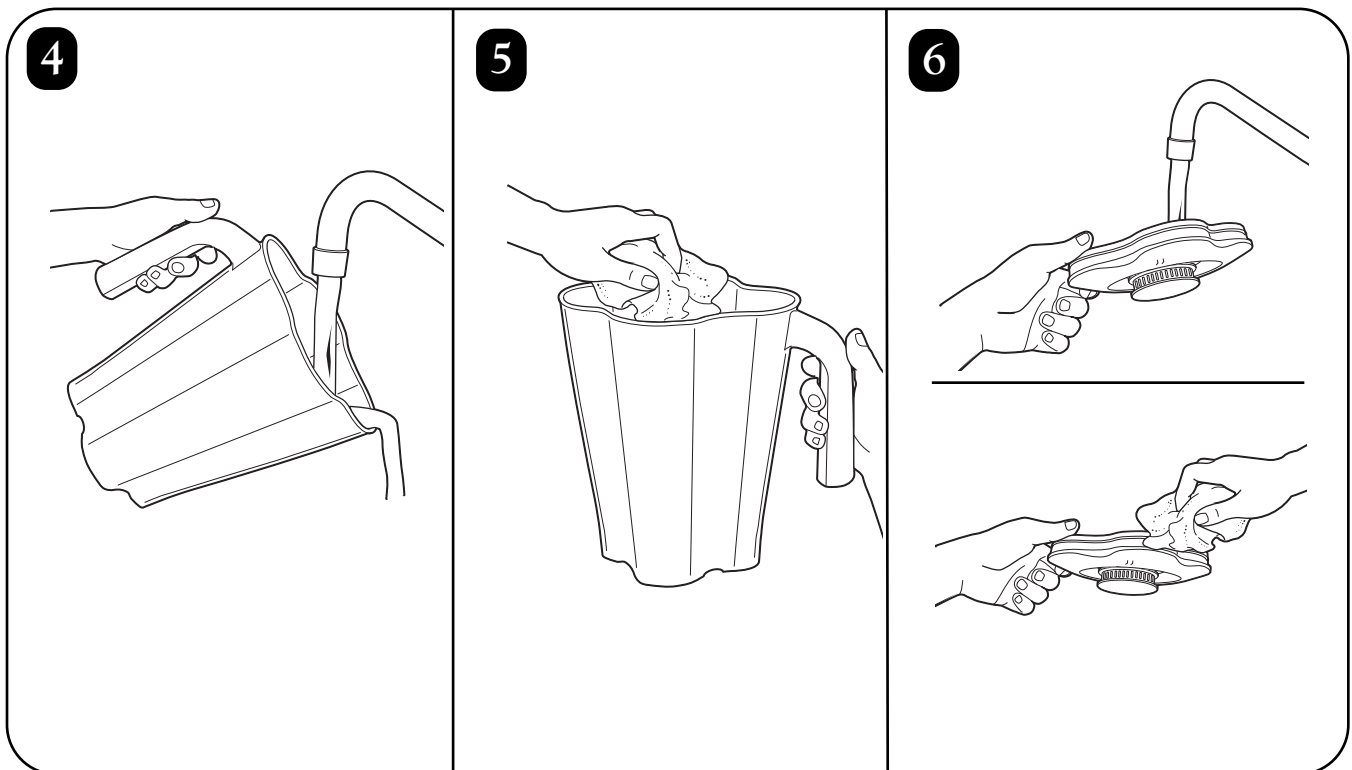
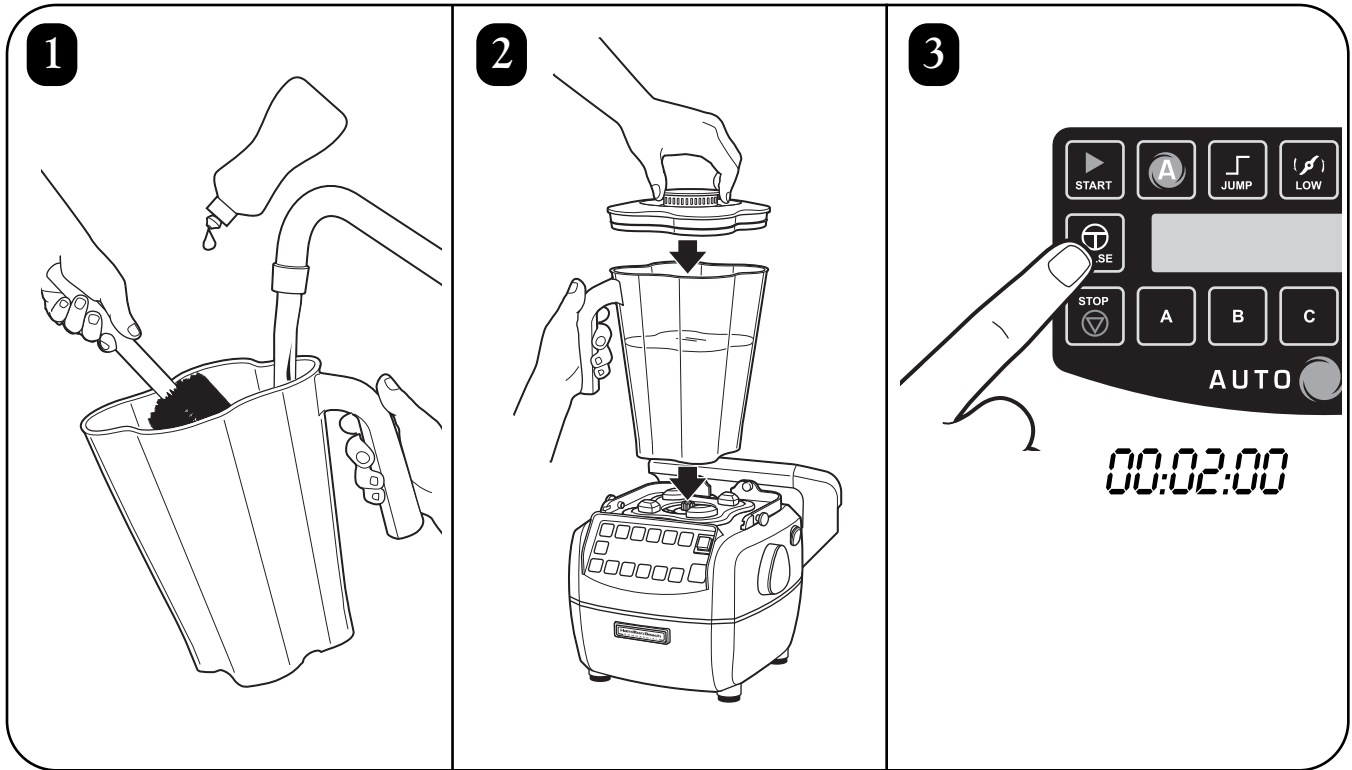
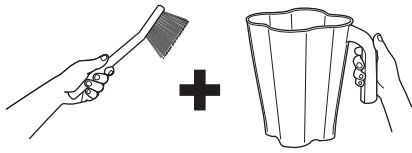

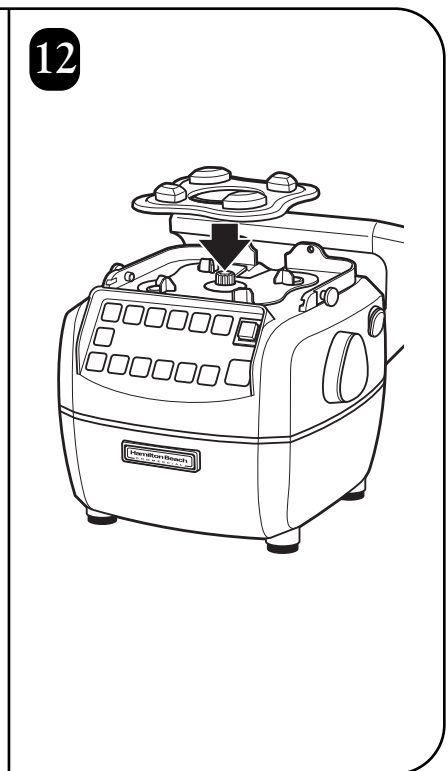
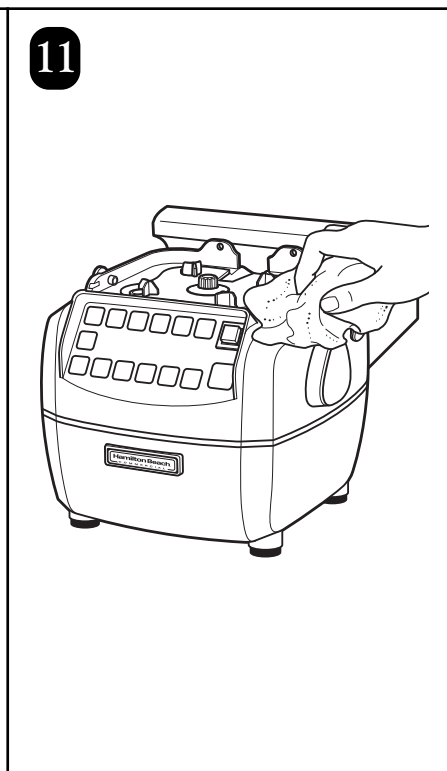
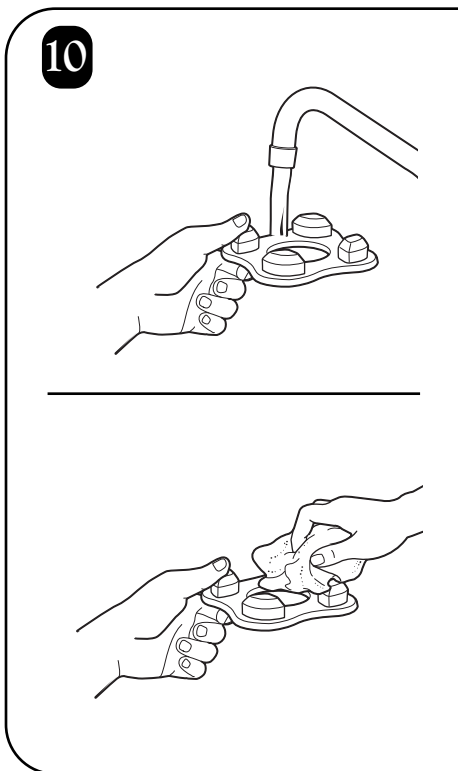
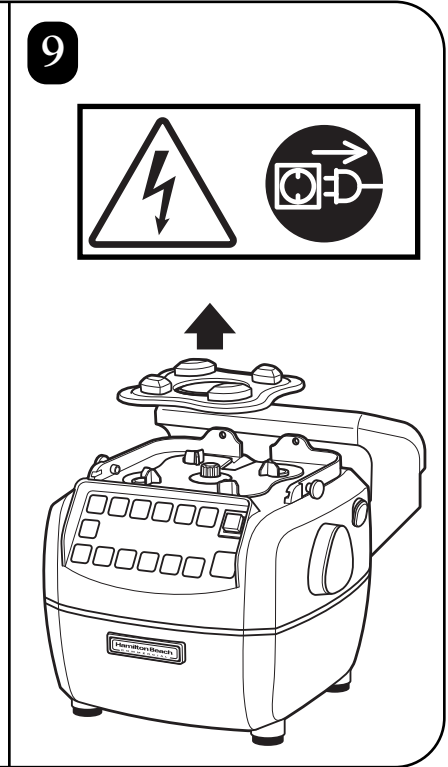
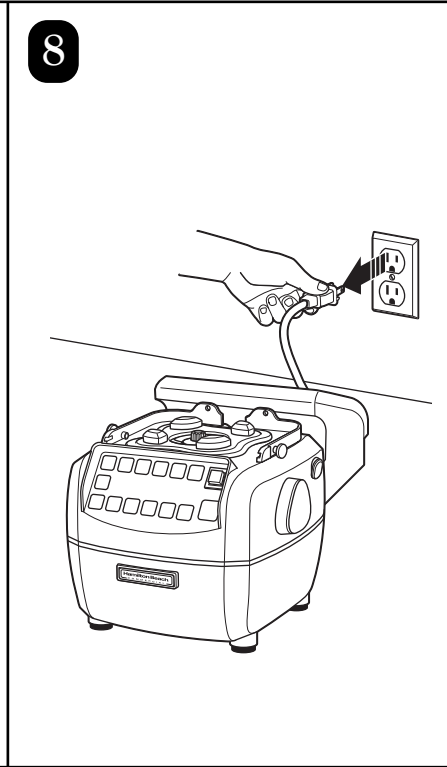
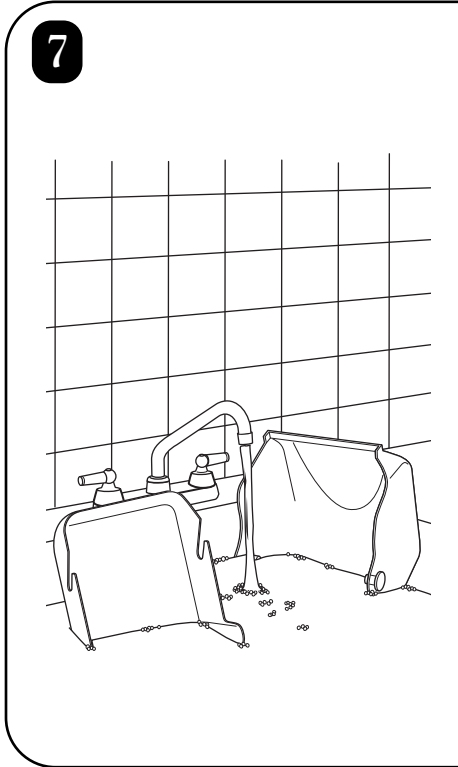
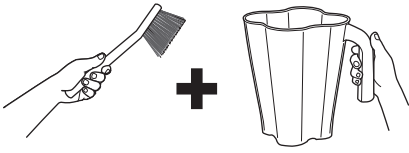

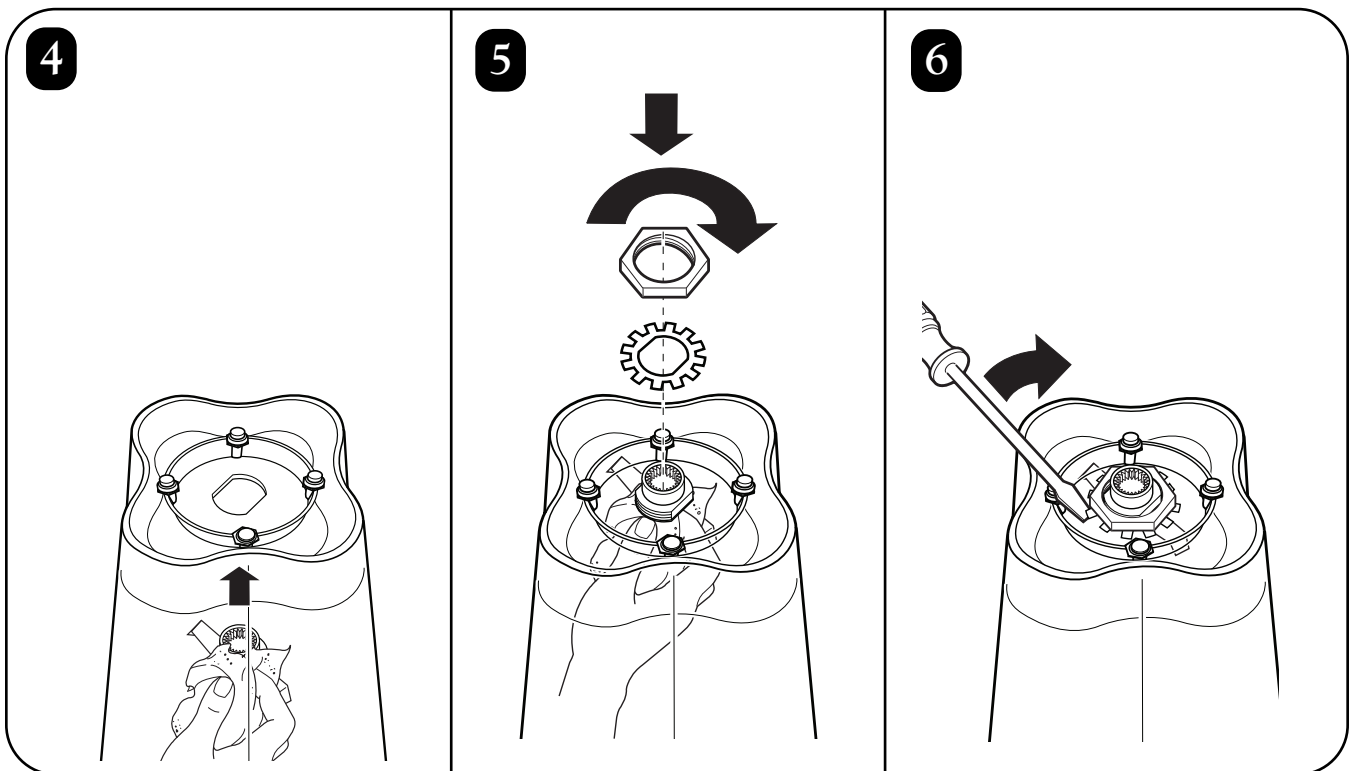
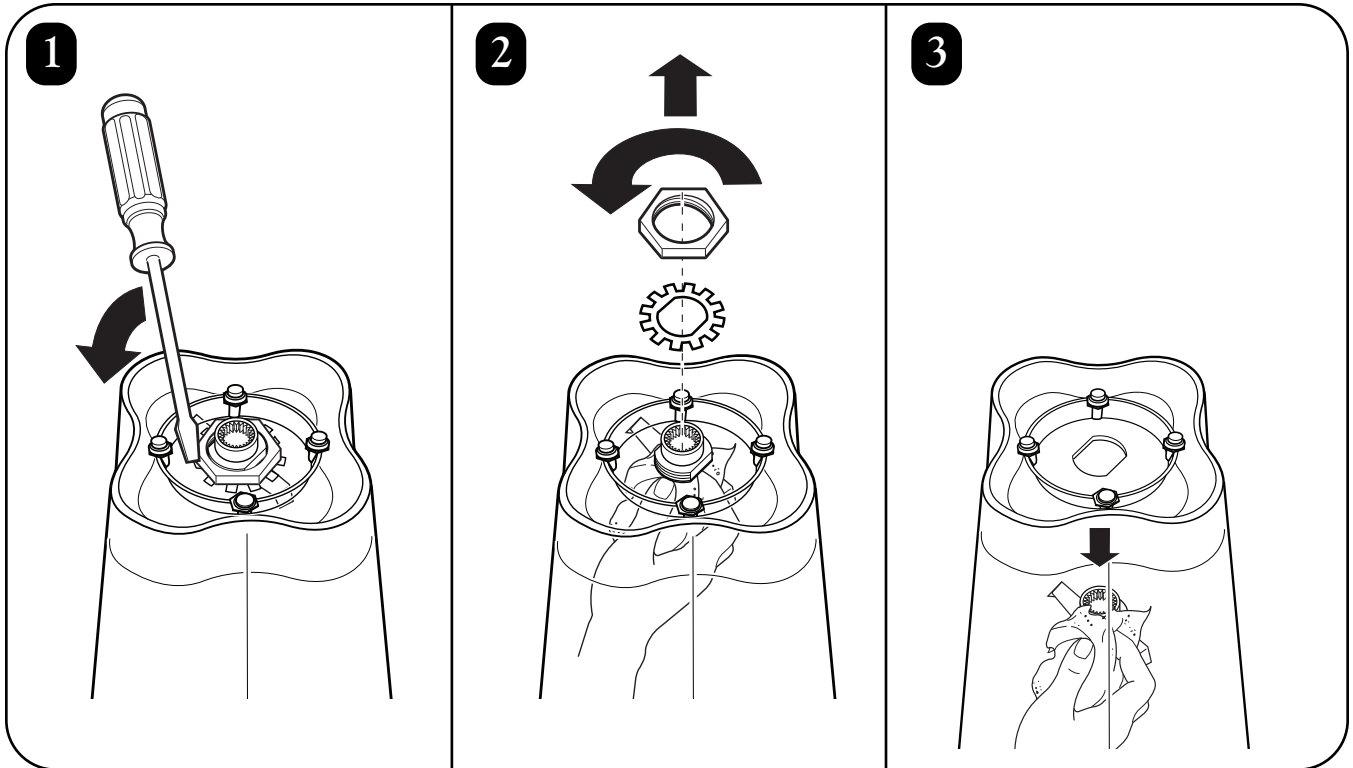
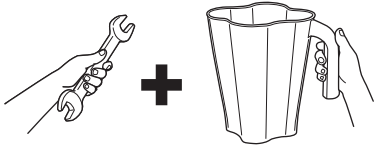











261 Yadkin Road  
Southern Pines, NC 28387